



Quality

We introduced roller shutter to our offer in 1997, you have to check it, it has been 25 years. Our proprietary designs are the result of work of our own research and development department.



Service

Professional and fast service is Drutex's calling card, which, for years, has been implementing the latest trends in pre- and post- sale Customer service.



Security

The roller shutters are equipped with an electric drive with detection, which affects the security level of their use.



Smart Home

Drutex's roller shutters and venetian blinds can be equipped with an intelligent control systems, compatible with windows, doors, gates or even home lighting and alarm systems.



31 Leborska Street, 77-100 Bytow
+48 59 822 91 01

— SINCE 1985 —

The information presented in this advertising material are informative and illustrative only. The product specification should be verified with the technical data specified by the manufacturer.



ROLLER SHUTTERS VENETIAN BLINDS INSECT SCREENS

MADE OUT OF PASSION
AND EXPERIENCE



TABLE OF CONTENTS



ROLLER SHUTTER SYSTEMS

RN Top-mounted Roller Shutters	06
Technical Specification	08
RS Top-mounted Roller Shutters	12
Technical Specification	14
RA Adaptive Roller Shutters	18
Technical Specification	20
Roller Shutter Colour Scheme	24

EQUIPMENT 26

VENETIAN BLINDS 28

SMART HOME INTELLIGENT CONTROL 30

PLEATED INSECT SCREENS 32

APPLICATION OF WINDOW SHUTTERS 34

MORE OF OUR PRODUCTS 42

Windows	44
Doors	45
Terraced systems	46
Facades, winter gardens	47



ROLLER SHUTTER SYSTEMS

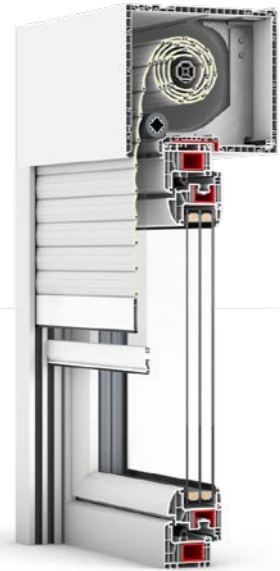

RN Top-mounted

RN 170, 180, 215, 225

A system of roller shutters integrated with the window, possible to apply during the construction of the house or when replacing the windows. Rich colour array of boxes and roller guides, made of PVC, and aluminium roller shutter curtains, as well as, variety of roller shutters' drives and protections, meet the customer expectations and modern building requirements.

p. 6

RS Top-mounted

RS 260, 300, 365, 425

Characterised by high acoustic and thermal insulation. Styrofoam roller shutter boxes, due to the innovative solutions and wide range of installation depth, can be used in any type of construction. Thanks to the wider winding diameter of the box, they are perfect for large glazing.

p. 12

RA Adaptive

RA 90°, 45°, 0°

Aluminium adaptive roller shutters have been designed for installation in both new and old buildings. Thanks to variety of shapes, sizes, and colours, in many cases they add a decorative element to the building. The undoubted advantages of this system are its various installation options.

p. 18

Venetian Blinds

ZF-A 240, 300
ZF-S 260, 300, 365, 425

Venetian Blinds are perfect for large glazing, protecting what is the most important-comfort of use. Thanks to unique solutions among others, continuous adjustment of the lath inclination angle, motor with obstacle detection, or possibility of control from a smartphone, blinds provide the buyer with the highest level of comfort.

p. 28



RN TOP-MOUNTED ROLLER SHUTTERS

BOX

p. 8

ROLLER GUIDES

p. 10

RN TOP-MOUNTED ROLLER SHUTTERS

RN 170, 180, 215, 225



PROTECTION AND AESTHETICS

Drutex's system of top-mounted roller shutters facilitates installation of the box from the inside and outside and therefore, only the roller guides, aluminium roller shutter curtain and the bottom revision cover are visible, which is an expression of modern construction referring to current trends in design.

Drutex's top-mounted roller shutters are a result of our own research and development department. Multiple innovative solutions, ensuring not only a comfort of use, but also excellent parameters in terms of energy efficiency have been implemented there. **The roller shutter can be equipped with an electric motor with detection**, which makes an influence on the security level. It can be controlled, among others, from a smartphone.

ALUMINIUM LATHS

filled with polyurethane foam

HEIGHT

170 mm or 180 mm and
215 mm or 225 mm
(depending on the window system)

BOX

side of the box in the shape of a rectangle with a revision

CONSOLE

steel

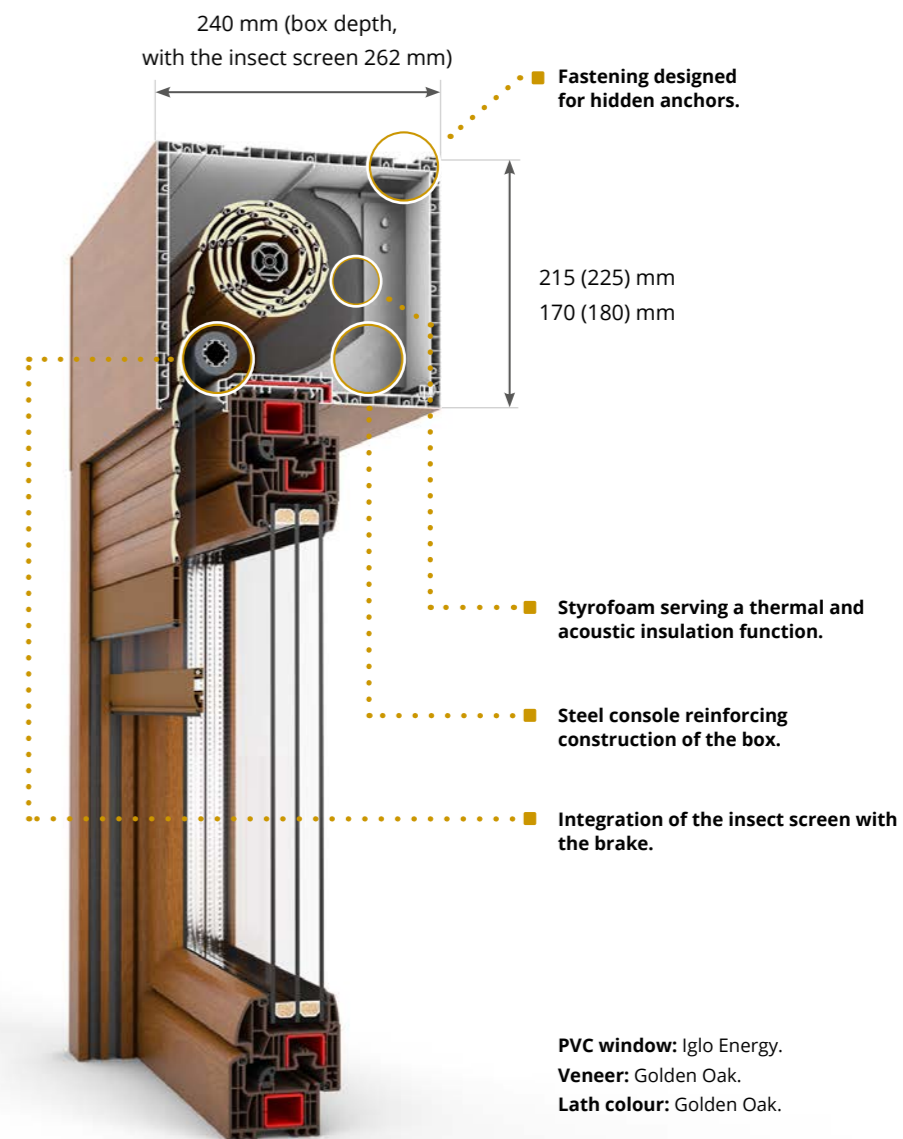

PVC window: Iglo Energy.
Veneer: Golden Oak.
Lath colour: Golden Oak.

TECHNICAL SPECIFICATION

ROLLER GUIDES

Wide range of types and colours of the roller guides allows matching an optimal solution to the customer's preferences.

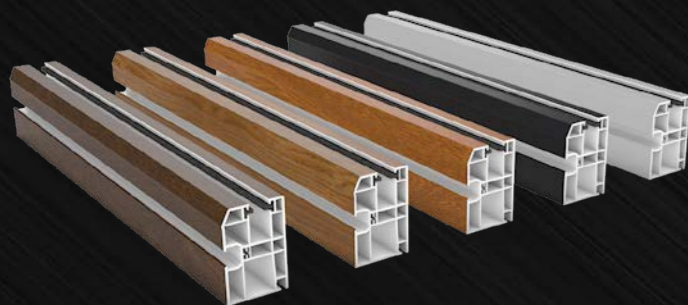

Box with a revision from the front.

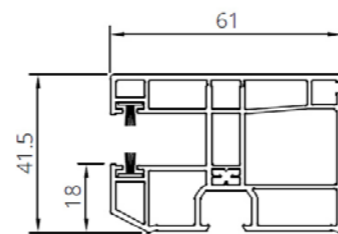

Roller guide (PVC) one-sided MINI.
R0001

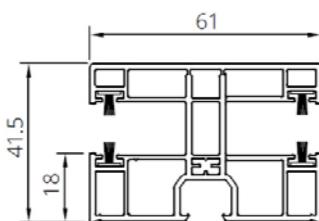

Roller guide (PVC) two-sided MINI.
R0002

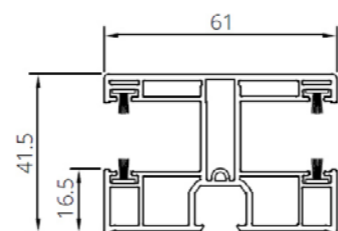

Roller guide (PVC) two-sided MAXI.
011309029

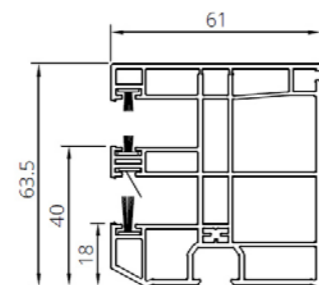

Roller guide (PVC) one-sided + MKT*.
R0003

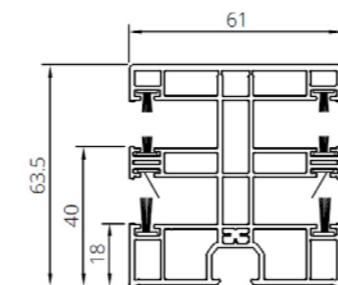

Roller guide (PVC) two-sided + MKT*.
R0004

*insect screen.



■ **A steel console in the Drutex's roller shutters** allows to obtain an optimal rigidity of the construction.

■ **A roller shutter's adapter - original project for Iglo 5, Iglo Light, Iglo Energy systems** equipped with a sealing, which ensures an optimal tightness and allows to obtain perfect parameters in terms of thermal insulation and air permeability.

■ **A specially designed reinforcement** ensures an optimal rigidity of a system, as well as, wind resistance.

■ **A 37 mm, 42 mm and 55 mm high laths are available** in various colour variants, enabling a full project arrangement. Depending on the installed window and used adapter the box height is 215 mm for Iglo 5 and Iglo Energy systems, and 225 mm for all other Drutex's systems. Sizes: 170 mm i 180 mm are used for window systems of a smaller measurements.

■ **A roller shutter has been designed so that**, the installation of an insect screen would be possible from the outside and inside of the roller shutter curtain.

■ **An access to the box**, for service works, is possible after opening the revision which is placed on the bottom or front of the box.

A possibility of applying a plaster carrier and flush-mounted bar for to integrate with the building's facade.

A bottom slat with a hidden stop.



RS TOP-MOUNTED ROLLER SHUTTERS

BOXES TYPES

p. 14

ROLLER GUIDES

p. 16

RS TOP-MOUNTED ROLLER SHUTTERS

ROLLER SHUTTERS WITH STYROFOAM BOX

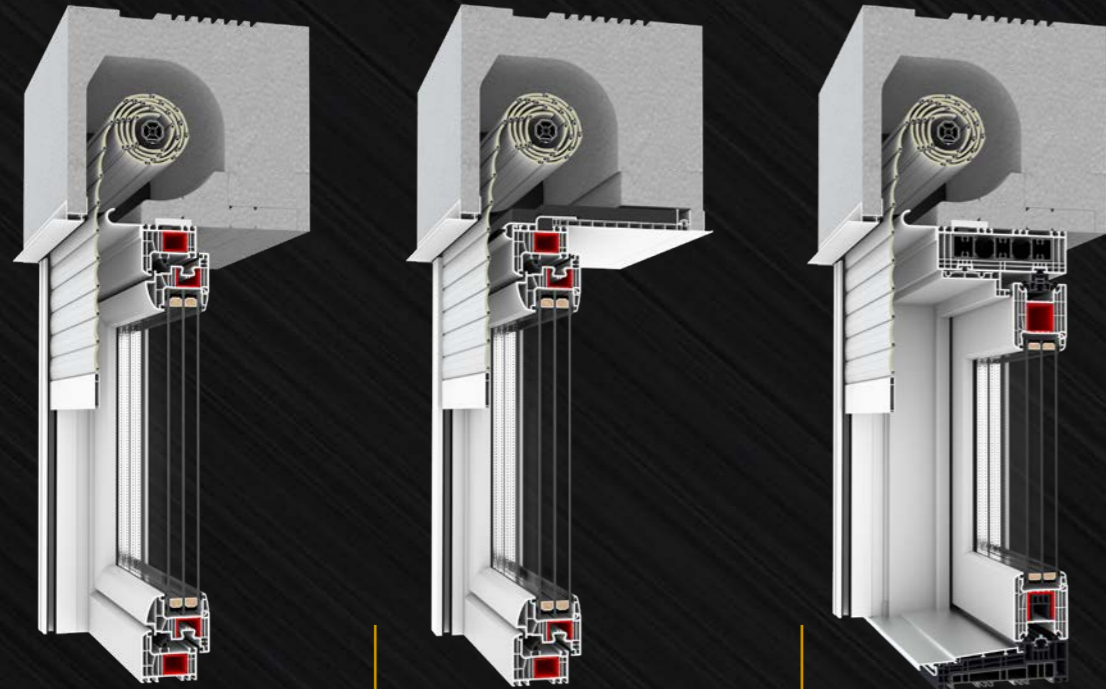

with revision from the outside.

with revision from the inside.

for HS system revision from the outside.



SECURITY AND ECONOMY

Owing to the fact that the system already has flush-mounted slats as standard, the boxes are prepared for direct plastering. The consoles, which we use, allow installation on larger-sized window suite products while maintaining stability of the entire construction.

Security:

- possibility of achieving RC2 anti-burglary resistance class.
- possibility of working with external alarm systems.

The product enables also matching the box depth to the wall depth. In the offer boxes of the following dimensions: 260 mm, 300 mm, 365 mm and 425 mm.

EVEN BETTER INSULATION

Great thermal and acoustic insulation parameters ensure high comfort of use. The box itself, as standard, provides mute on the level up to 49/47 dB. The roller shutters also have a significant impact on reducing the heat loss in a building.

Revision from the inside

Box size	U thermal insulation	dB acoustic insulation
260/275 mm	0,79	45/45
300/308 mm	0,67	45/44
365/308 mm	0,57	45/44
425/308 mm	0,54	-

Revision from the outside

Box size	U thermal insulation	dB acoustic insulation
260/243 mm	0,65	48/47
300/308 mm	0,46	49/47
365/308 mm	0,37	49/47
425/308 mm	0,34	47/46

Boxes types

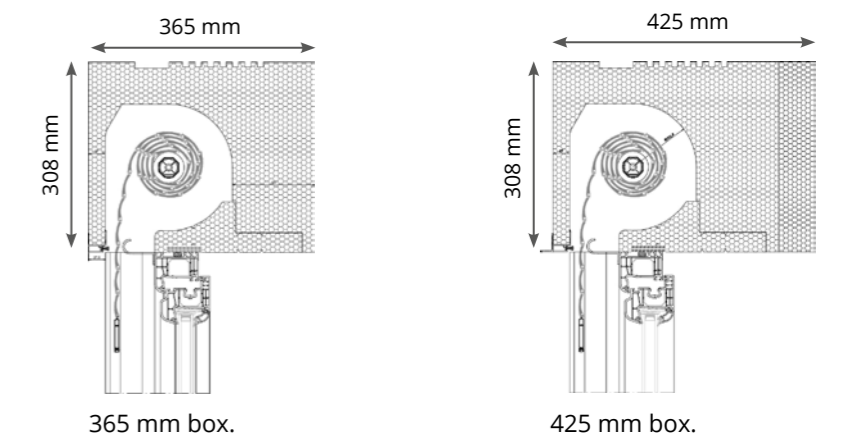
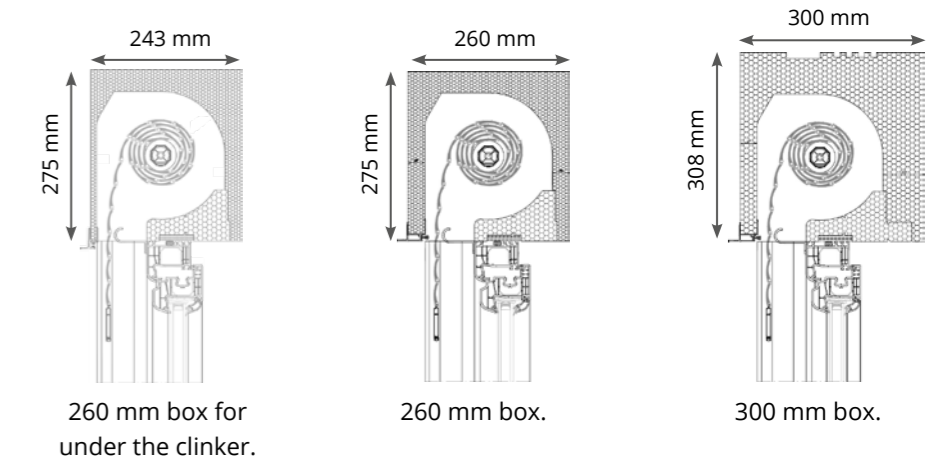

TECHNICAL SPECIFICATION

ROLLER GUIDES

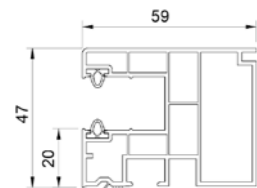

One-sided (PVC) roller guide - RS revision from the inside.
MKM928(7)

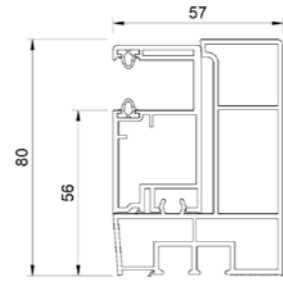

One-sided (PVC) roller guide - RS revision from the outside.
MK933 + MK9760

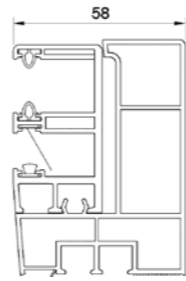

One-sided (PVC) roller guide + MKT* - RS revision from the outside.
MK8120 + MK9760

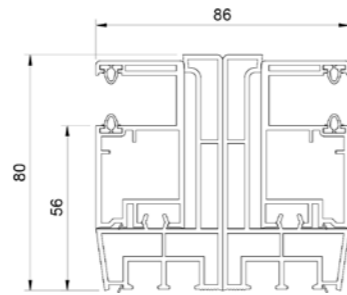

Divisive (PVC) roller guide - RS revision from the outside.
MK933 + MK9730

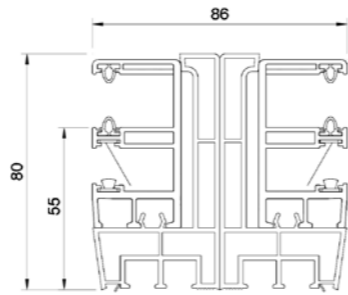

Divisive (PVC) roller guide + MKT* - RS revision from the outside.
MK8120 + MK9730

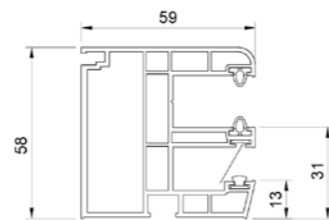

One-sided (PVC) roller guide + MKT* - RS revision from the inside.
MK8110



Divisive (PVC) roller guide - RS revision from the inside.
MK939

*insect screen.

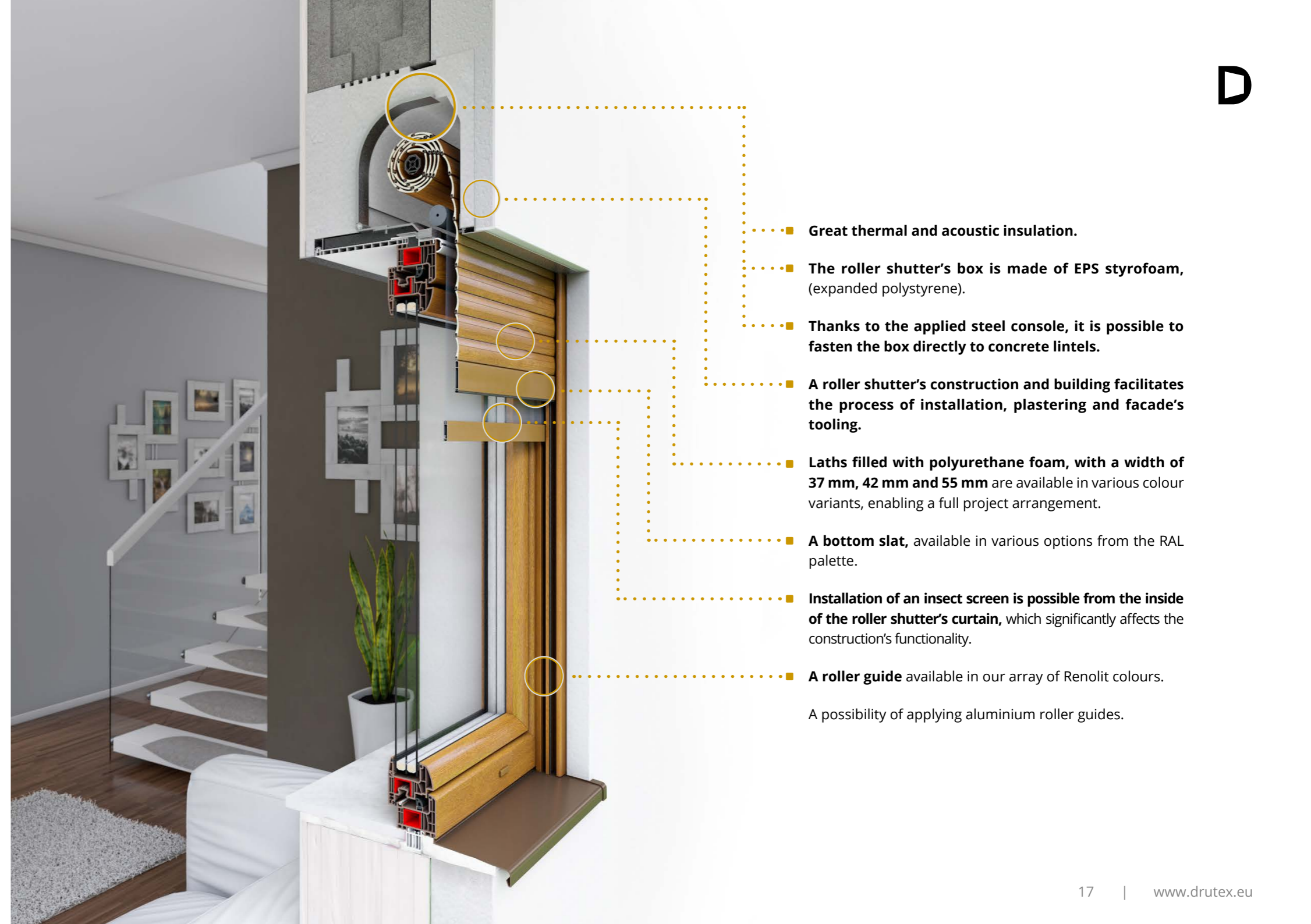

- **Great thermal and acoustic insulation.**
 - **The roller shutter's box is made of EPS styrofoam, (expanded polystyrene).**
 - **Thanks to the applied steel console, it is possible to fasten the box directly to concrete lintels.**
 - **A roller shutter's construction and building facilitates the process of installation, plastering and facade's tooling.**
 - **Laths filled with polyurethane foam, with a width of 37 mm, 42 mm and 55 mm are available in various colour variants, enabling a full project arrangement.**
 - **A bottom slat, available in various options from the RAL palette.**
 - **Installation of an insect screen is possible from the inside of the roller shutter's curtain, which significantly affects the construction's functionality.**
 - **A roller guide available in our array of Renolit colours.**
- A possibility of applying aluminium roller guides.



RA ADAPTIVE ROLLER SHUTTERS

BOXES TYPES

p. 20

ROLLER GUIDES

p. 22

ADAPTIVE ROLLER SHUTTERS

ALUMINIUM ROLLER SHUTTER SYSTEM



90° FLUSH-MOUNTED ROLLER SHUTTER

Dimensions: 137x137 mm, 165x165 mm or 180x180 mm (width and height of the box). The flush-mounted roller shutter has an external revision. Thanks to the plaster carriers (extra option), it is suitable for a direct plastering. It can be installed in the external insulation of the building.



OVAL ROLLER SHUTTER

Dimensions: 139x145 mm, 167x171 mm, 182x190 mm (width and height of the box). Thanks to its shape, it makes an interesting decorative element of the building.



45° ROLLER SHUTTER

Dimensions: 137x137 mm, 165x165 mm and 180x180 mm (width and height of the box). The system is made of a bent sheet. Due to the use of 45° angle bent, it is characterised with a high construction rigidity. Easy revision access allows any maintenance service without disassembling the roller shutter.

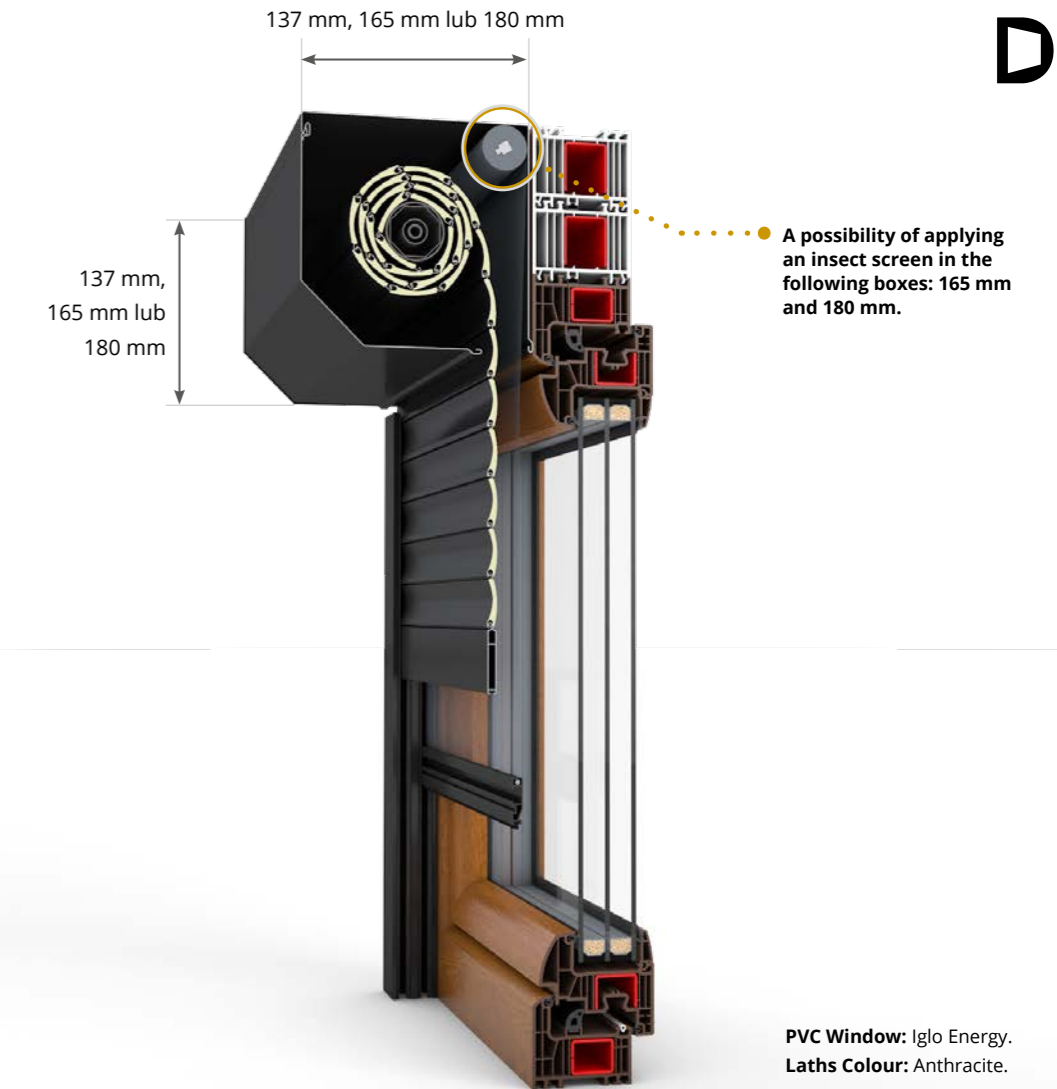

A system of external aluminium roller shutters is designed for application in the already existing buildings or ones being under construction. The roller shutter is entirely made out of aluminium, available in the chosen colour shades from the RAL palette and wooden-like colours. Its rigid construction is ensured by the high quality materials and well-thought-through construction, which is a result of the work of our own research and development department and that allows matching to any architectural style. A sheet which makes the cover of the console, is a subject to a unique system of multiple bends what increases its strength.

ALUMINIUM LATHS

filled with polyurethane foam

HEIGHT

137 mm, 165 mm or 180 mm
(depending on the system)

BOX

revision from the outside

TECHNICAL SPECIFICATION

ROLLER GUIDES

Availability of various system and colour variants allows matching an optimal solution to the customer's preferences.

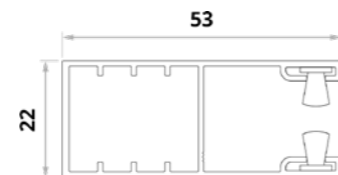
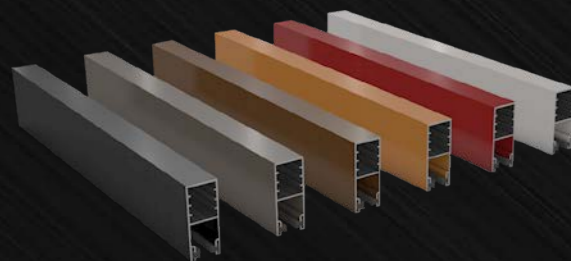

One-sided roller guide (for H37 and H42 laths).
87857

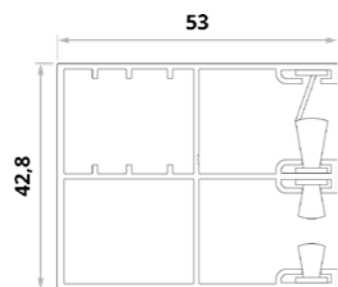

One-sided roller guide with an insect screen (for H37 and H42 laths).
87859

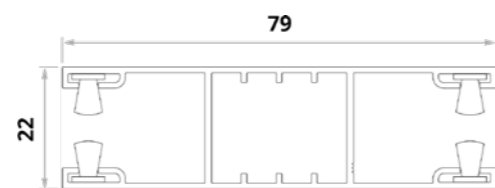

Two-sided roller guide (for H37 and H42 laths).
87858

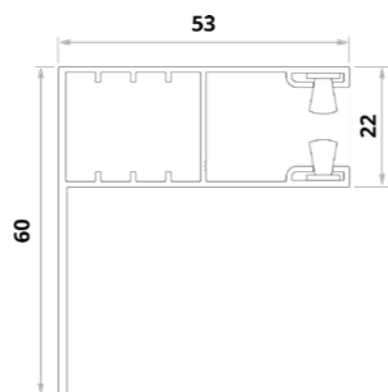

Angle roller guide (for H37 and H42 laths).
87856

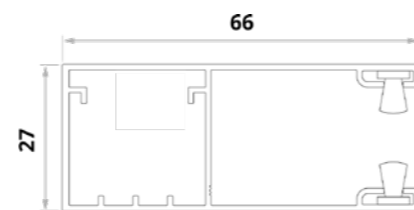

One-sided roller guide (for H55 laths).
PP6600



■ **A roller shutter box, thanks to a rich array of colours can be a decorative element of a building.**

■ **Access to the box** for 45° roller shutter and oval roller shutter – from the front, while for flush-mounted roller shutters – from the bottom.

■ **A box and roller guides** available in a rich RAL palette colours thanks to which the roller shutters are distinguished by aesthetics and modern look.

■ **A roller shutter curtain is built out of aluminium profiles**, filled with polyetherane foam, rolled into a box located on the wall or in the window frame

■ **A bottom slat with a hidden stop** available in the chosen colour options from the RAL palette, which allows to maintain the consistency with the building's facade and moreover, affects the elegance of the construction.

There is a possibility of making an insect screen **integrated with the roller shutter**.

Boxes and roller guides available in the colours of the RAL palette*.



* Up-to-date list of colours available at www.drutex.eu and at dealer's.

UNAVAILABLE RAL COLOURS (up-to-date list at your dealer):

1035 | 1036 | 2013 | 3032 | 3033 | 4011 | 4012 | 5025 | 5026 | 6035
6036 | 7048 | 8029 | 9022 | 9023 | 1026 | 2005 | 2007 | 3024 | 3026
6038.

ROLLER SHUTTER COLOUR SCHEME

STANDARD

Laths filled with polyurethane foam, with a width of 37 mm, 42 mm and 55 mm, are available in various colour variants.

ROLLER SHUTTER CURTAIN COLOUR SCHEME

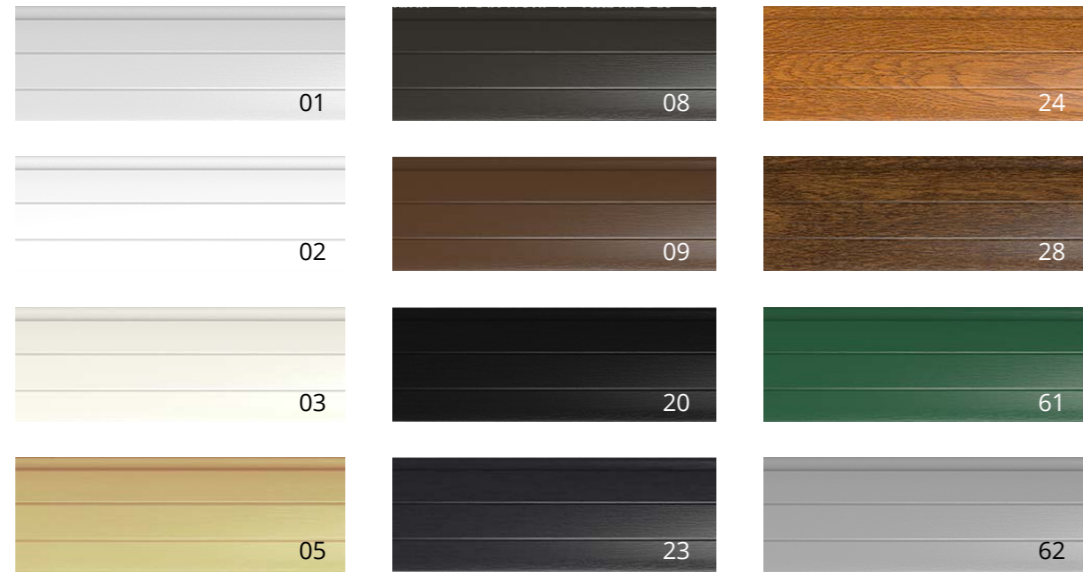

AVAILABLE COLOURS FOR THE PARTICULAR LATH HEIGHTS

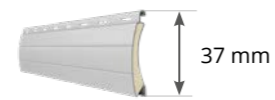

- 01 Silver
- 02 White
- 03 Grey
- 05 Beige
- 08 Dark Brown
- 09 Brown
- 20 Black
- 23 Anthracite
- 24 Golden Oak
- 28 Nut
- 61 Moss Green
- 62 Grey Aluminium

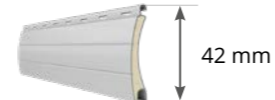

- 01 Silver
- 02 White
- 03 Grey
- 08 Dark Brown
- 20 Black
- 23 Anthracite



- 02 White
- 03 Grey
- 08 Dark Brown
- 23 Anthracite

OPTIONAL

ROLLER GUIDES COLOUR SCHEME FOR RS ROLLER SHUTTERS

ROLLER GUIDES AND BOXES COLOUR SCHEMES FOR RN ROLLER SHUTTERS



* Up-to-date list of colours available at www.drutex.eu and at dealer's

EQUIPMENT

SYSTEM OF TOP-MOUNTED
ROLLER SHUTTERS WITH
A PVC BOX

Bottom slats



Roller shutter curtain bottom slat.



Insect screen bottom slat.

Adapter



Universal adapter as standard.

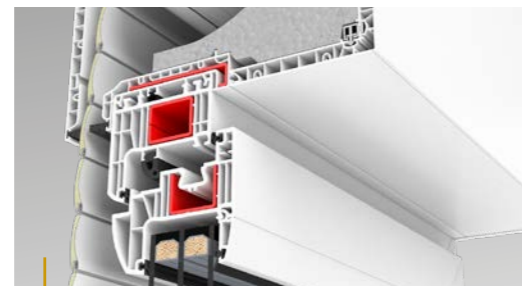

Iglo Energy adapter.

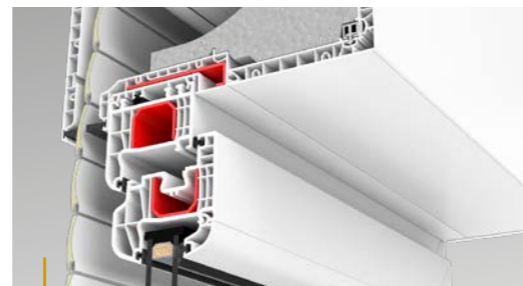

Iglo 5 adapter.

Options

Innovative elements of Drutex roller shutter construction, associated with the presence of the adapter and reinforcing console, distinguish the system from other producer's constructions, guaranteeing exceptional insulation and durability of the roller shutter.

Switches



PK1 - basic switch.



PKLU - key switch.



SMOOVE wall transmitter.

Remotes



Situ 5 io Pure II 5-channel remote.



Situ 1 io Pure II 1-channel remote.



SOMFY Situ 5 Var IO Pure II - 5 channel remote.



SOMFY Situ 1 Var IO Pure II - 1-channel remote.



Dedicated Drutex remote.

Retractors and Cranks



Manual belt retractor- 14 mm (maximum load up to 11 kg).



PKR gear with a disengaging crank (maximum load up to 20 kg).



PKS gear with a fixed crank (maximum load up to 20 kg).

Console



From 1800 mm stabilising console as standard.



WB hanger is mounted as standard for the electric drive (so called, hanger-blockade), which prevents the roller shutter curtain from being lifted up.

VENETIAN BLINDS Timeless look

COMFORT AND JOY OF USE

Venetian blinds are a perfect solution protecting room interior against excess of sunlight. Thanks to its installation, both in residential, and commercial buildings, such as; offices, hotels, public buildings, not only can provide more privacy, but also significantly decrease use of electric energy, which is being used by air conditioning systems. Drutex's venetian blinds are consistent with contemporary architectural trends, which favour large glazing where no other than facade type of shutters can be applied. What is important, this product can be used for both new and already existing buildings. Its great advantage is also a possibility of merging with an intelligent management systems, which allow controlling with a tablet or smartphone.



AVAILABLE LATHS FOR ADAPTIVE AND TOP-MOUNTED VENETIAN BLINDS



C80 Lath



S90 Lath



Z90 Lath

ADAPTIVE VENETIAN BLINDS

Available dimensions (width x height.):
140x240 mm, 140x300 mm.

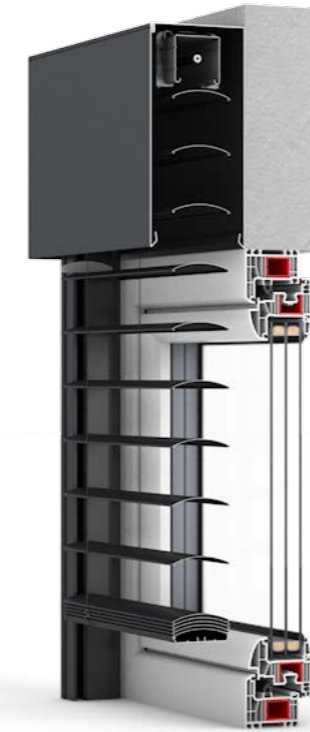

TOP-MOUNTED VENETIAN BLINDS

Available dimensions (width x height.):
260x275 mm, 300x308 mm,
365x308 mm, 425x308 mm.

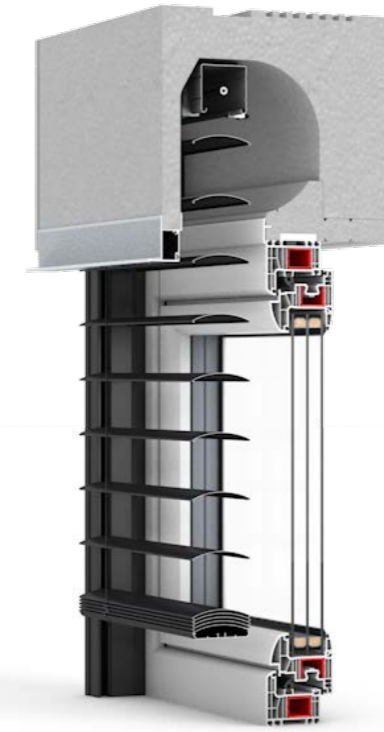

Available Lath Colours



RAL 7016

RAL 9005

RAL 9006

RAL 9007

RAL 9016

DB 703

For adaptive roller shutters and venetian blinds, we use matt paints.

Thanks to the free adjustment of the angle of inclination of the laths, they enable an optimal level of shading and create a nice atmosphere in the rooms of the building. They reflect most of the sunlight in front of the window, ensuring comfortable conditions in the apartment or house. Controlling with a wireless remote controller or a smartphone. We recommend equipping venetian blinds with a weather station.

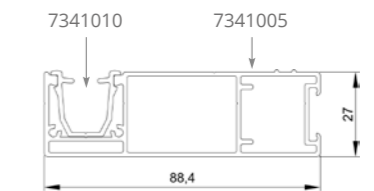

Single roller guide
for ZF-A as standard.

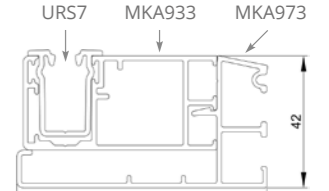

Single roller guide
for ZF-S as standard.

i Possibility of applying a PVC roller guide for the box of top-mounted venetian blind.



A roller guide with a drainage profile for a maximum distance of 260 mm also available in the offer.

SMART HOME INTELLIGENT CONTROL

Comfortable management

Intelligent roller shutter control systems, using a remote controller, tablet or a smartphone, are becoming more and more popular among customers which allows to manage the system remotely when absent. There is a possibility of opening and closing the roller shutter separately or in groups, as well as, time programming and merging with other intelligent systems at home. It is an investment in comfort of use and functionality on the highest level.



TaHoma® switch

Windows, doors, roller shutters, venetian blinds, gates and wickets, which, thanks to the intelligent Somfy- TaHoma® switch control panel, can open and close themselves at a given time of the day. Moreover, they can tilt or slide in integrated groups or separately, at the same time ensuring a full control and surveillance of the house, even when nobody is there. TaHoma® switch also allows to manage the house and garden lighting.



BleBox product line

These are miniature devices which allow opening and closing of doors, windows, roller shutters, awnings, venetian blinds, gates, as well as, managing the lightning and alarm systems with a smartphone or tablet- also from any place in the world.



Drutex dedicated remote controller.

Electric drives

Automatic setting of end positions, obstacle detection and overload blokage. Hangers with blockage as standard.



SOMFY Oximo S Auto RS100 IO 10/17

A drive cooperating SOMFY Tahoma system, which has an overload protection, obstacle and icing detection, remotely controlled.

Available models:

- Oximo S Auto IO 6/17 (short)
- RS100 IO 10/17
- RS100 IO 15/17 (strong).



SIMU T5 Auto 10/17

A modern remote control drive SIMU has the functions of auto-control of endpoints, obstacle detection and overload blockage.

Available models:

- T3,5 AUTO+ 9/16 / fi 40 roller
- T3,5 AUTO+ 13/10 / fi 40 roller
- T5 AUTO 10/17 / fi 60 roller
- T5 AUTO 15/17 / fi 60 roller.



SELVE SP Rescue (rescue exit)

Universal drive with a mechanical limit switch and emergency opening within seconds.



SELVE SEE-NHK

Electric drive for roller shutters with a mechanical operating of an emergency opening with a crank.

Advantages of SELVE SP Rescue drive:

- opens roller shutters and ensures a second escape route within 1-2 seconds- also in case of power failure
- intuitive one-touch operation
- the endpoints remain unchanged after returning to the operating mode
- entirely mechanical solution, maintenance-free.

PLEATED INSECT SCREENS



POSSIBLE VARIANTS

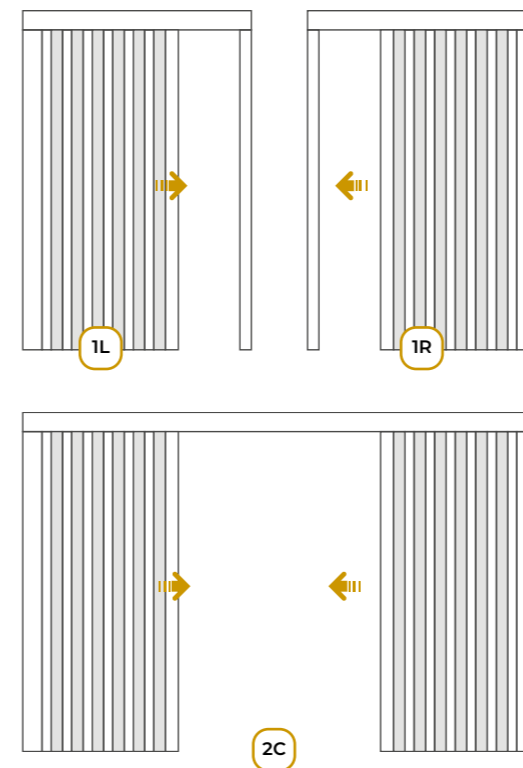

Maximum dimensions

Type of window suite	Width mm	Height mm
Single leaf	2400	2600
Double leaf	3600	2600

Minimum dimensions: 700 mm x 1900 mm (width x height).

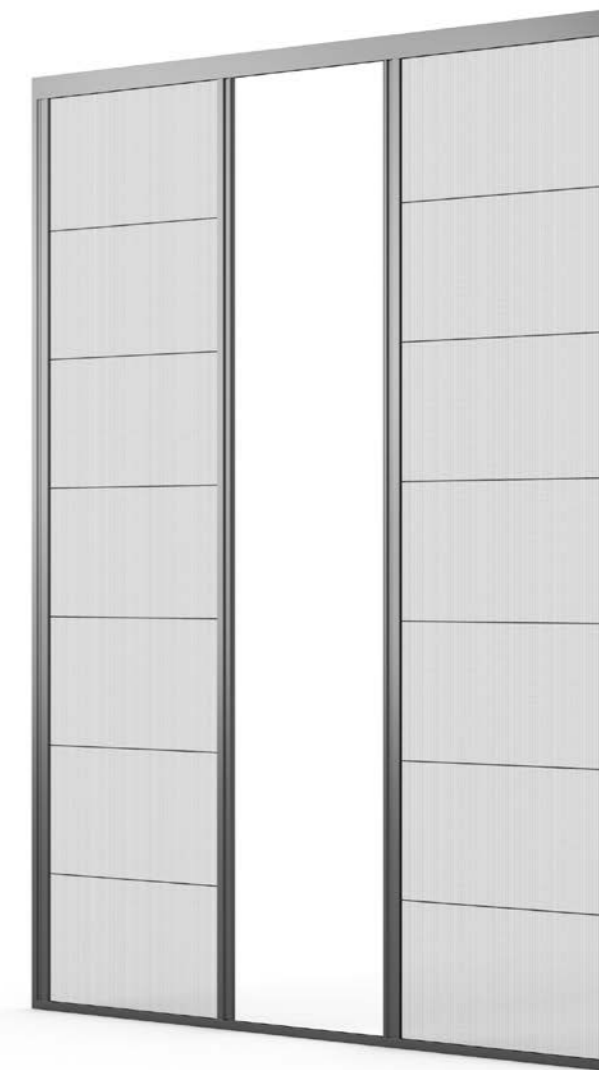

Well-thought-through and refined in the smallest detail design enables installation in the window recess, on the window frame, on the building's facade, and in our roller shutters' roller guides. The choice of matt colours allows for an aesthetic consistency with the facade of the building.

AVAILABLE COLOURS (MATT)



* Up-to-date list of colours available at www.drutex.eu and at dealer's



APPLICATION OF WINDOW SHUTTERS

RS 425 top-mounted roller shutters, Golden Oak colour.

WINDOW SHUTTERS



RA 45° adaptive roller shutters, anthracite colour.



ZF-A venetian blinds, anthracite colour.



WINDOW SHUTTERS

RS 365 top-mounted roller shutters, anthracite colour.



RS 365 top-mounted roller shutters, moss green colour.



WINDOW SHUTTERS

RA 45° adaptive roller shutters, brown colour.



RA 45° adaptive roller shutters, dark brown colour.





SEE MORE OF OUR
PRODUCTS

WINDOWS

PVC
aluminium
wood
wood-aluminium

Our windows are distinguished by the highest quality, modern design, high resistance to unfavourable weather conditions as well as very good thermal and acoustic insulation. For production we use modern machines and devices from renowned global producers. Wide array of colours is provided by the Renolit foils (PVC windows), opaque and azure paints (wooden windows), and one of the most modern powder paint shops in the world (aluminium windows). Reliable fittings and other high quality additional equipment ensure the comfort of use.



DOORS

PVC
aluminium
wood

Drutex exterior doors mean very good thermal insulation parameters, various arrangement and functional possibilities as well as modern design and security. Highest quality components and equipment, used in the process of production, helped in creating product worthy of XXI century.

TERRACE SYSTEMS

Unique design, ensuring a great access of daylight to the house and at the same time maintaining excellent parameters in terms of energy efficiency. Great configuration possibilities allow to cope with the most demanding customers. Application of our systems will not only add character to the usable area, but also make the building look more attractive from the outside.



FACADES WINTER GARDENS

Aluminium facades and winter gardens are the perfect choice for fans of innovative technologies, various arrangement and utility possibilities as well as modern design combined with outstanding security. The latest technology of powder painting ensures material protection even in the most demanding environmental conditions. Combined with the wide RAL colour palette and wood-like colours it makes an exceptional offer on the global market of the aluminium window suite products.